



GUARDSMAN[®]

Galvanized Riveted Ornamental Steel Fence



Merchants Metals[®]
the first name in fence solutions

Riveted Steel Fence Systems

Guardsman® combines the traditional style and flexibility of riveted construction with modern technology to provide long-lasting beauty and security in a high-quality ornamental steel fence system.

Every Guardsman® section is factory assembled by highly trained craftsmen. The process begins with pre-galvanized steel, which creates a powerful layer of protective coating. The pickets and rails are then connected with high-quality aluminum rivets, giving the fence additional strength and the flexibility to move up and down along the terrain.

Once assembled, the panels are then sent through our 10 stage powder coating process which produces a superior, long lasting powder coat finish.

The classic design, high quality construction and variety of heights and styles make Guardsman® the architect's choice in ornamental steel fence.

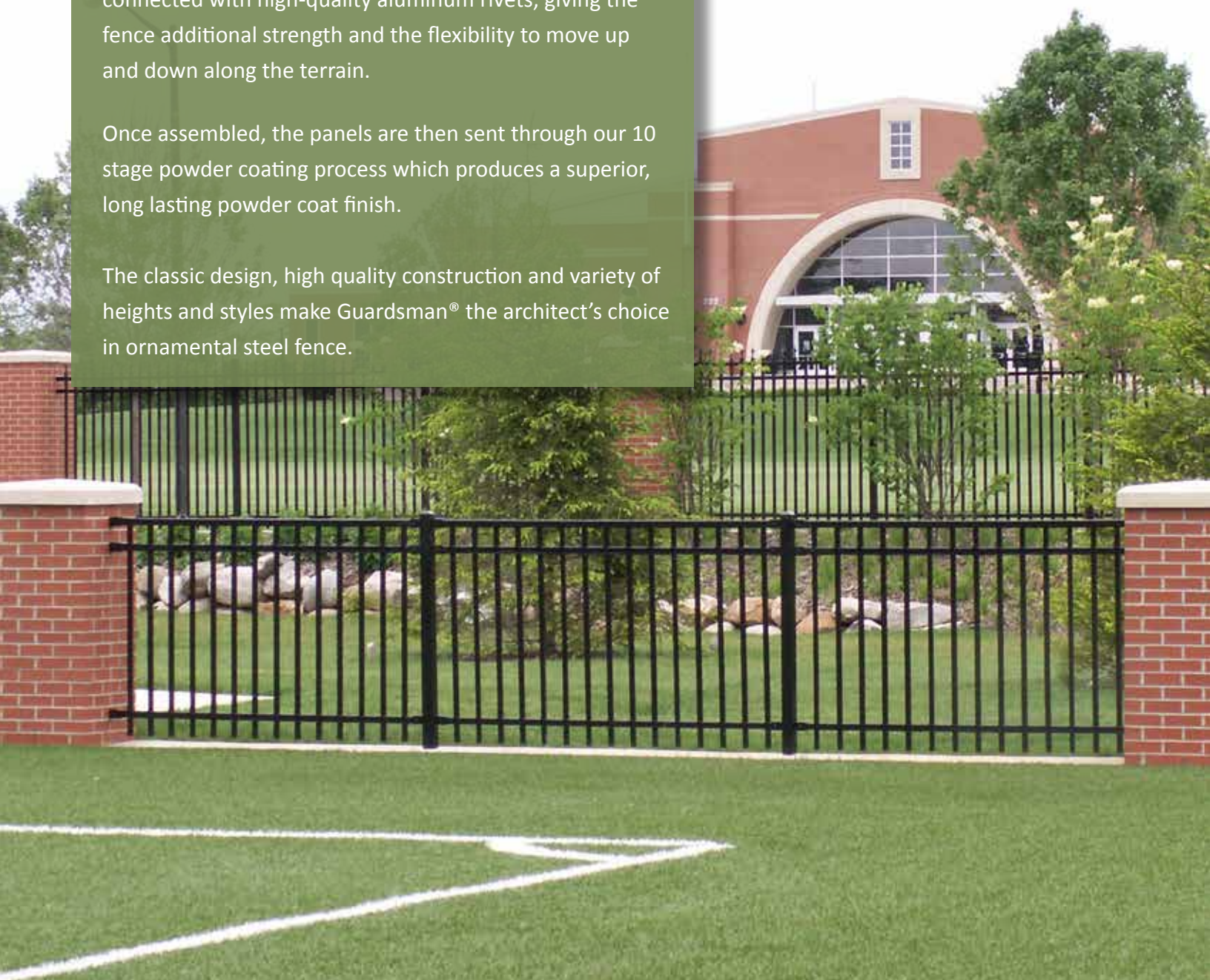

MONROE 3 RAIL



KENT 3 RAIL WITH FINIALS



CURVED TOP 4 RAIL



MONROE 4 RAIL WITH RINGS

GUARDSMAN® FEATURES

- Galvanized Steel Components
- Durable Powder Coat Finish
- 15 Year Limited Warranty
- Fully Assembled Panels
- Riveted Construction
- Maintenance Free
- Commercial and Industrial Applications

BLACK

WHITE

BROWN

GREEN

BRONZE

Advanced powder coating adds a beautiful finish which also protects against the elements

Patented High-Security Bracket

Galvanized 11 gauge steel channel adds strength and durability

Each 1/4 in. aluminum rivet has 1,500 lbs. of shear strength and 1,100 lbs. of holding power

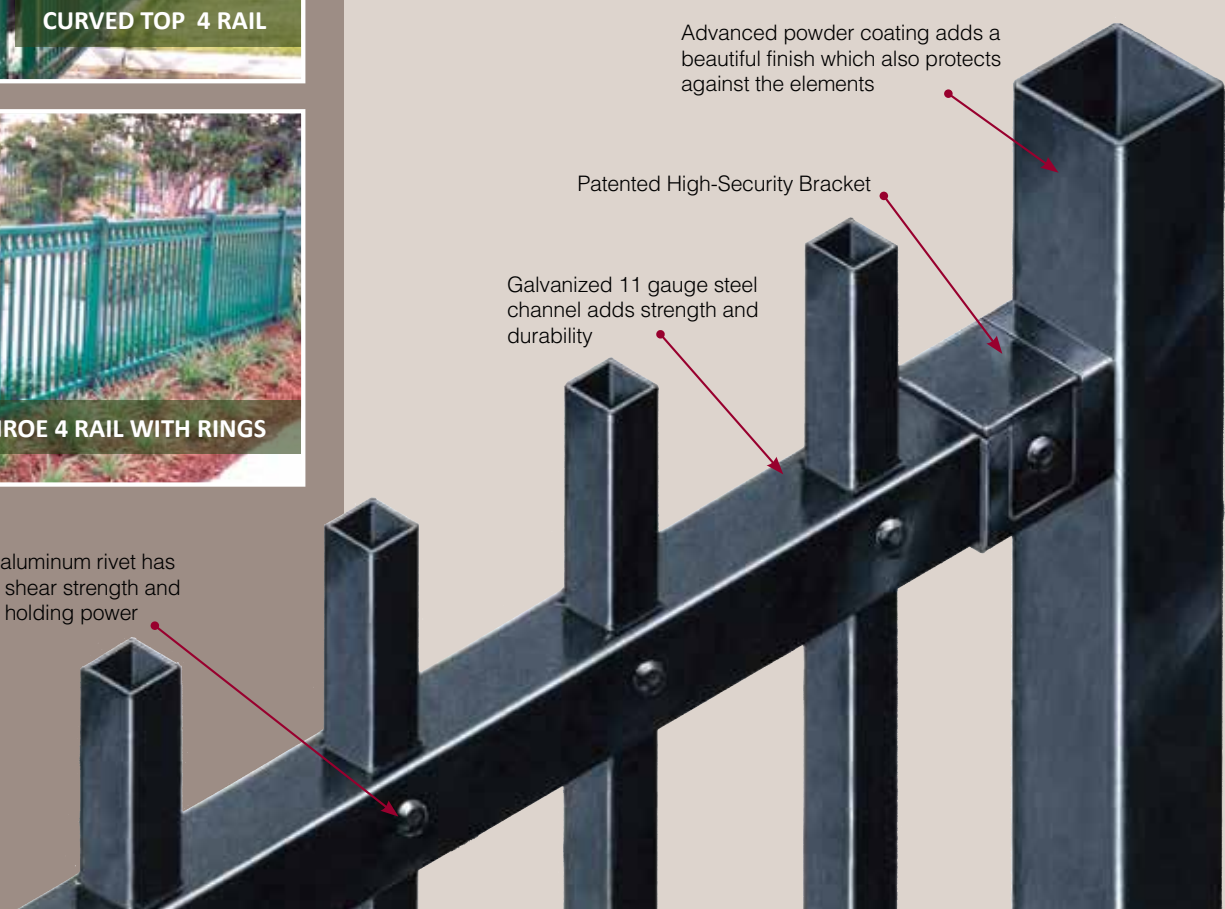

Lafayette

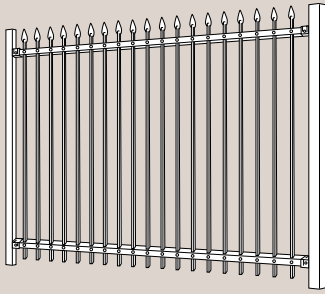

2 Rail

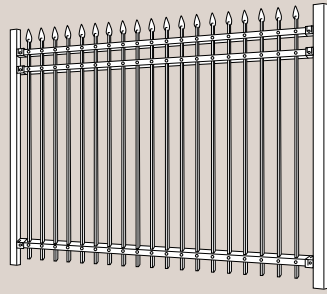

3 Rail

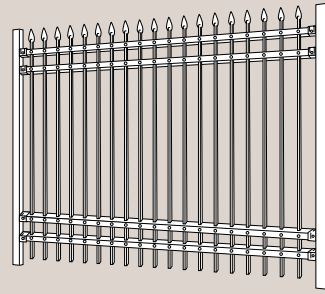

4 Rail

Lafayette Panels

A secure and elegant design with pressed point pickets.

Available in 2, 3 or 4 rail styles.

Curved Top

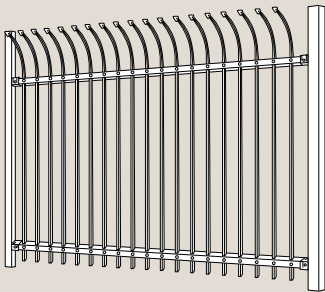

2 Rail

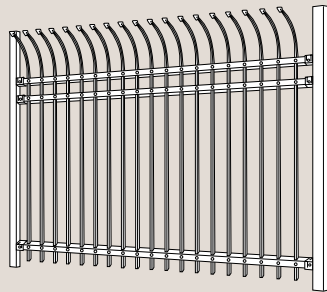

3 Rail

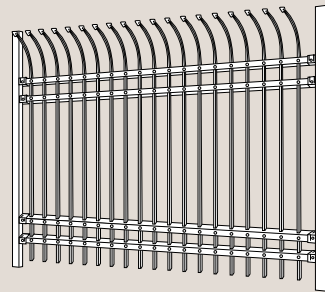

4 Rail

Curved Top Panels

A high security design which creates an imposing presence with a sense of style.

Available in 2, 3 or 4 rail styles.

Guardsman® Assembly

All Guardsman® fence systems are assembled at the Merchants Metals factory to minimize your installation time and ensure long-term structural integrity. After powder coating, the fence panels and posts are shipped on carefully packaged pallets for economical and damage-free transit.

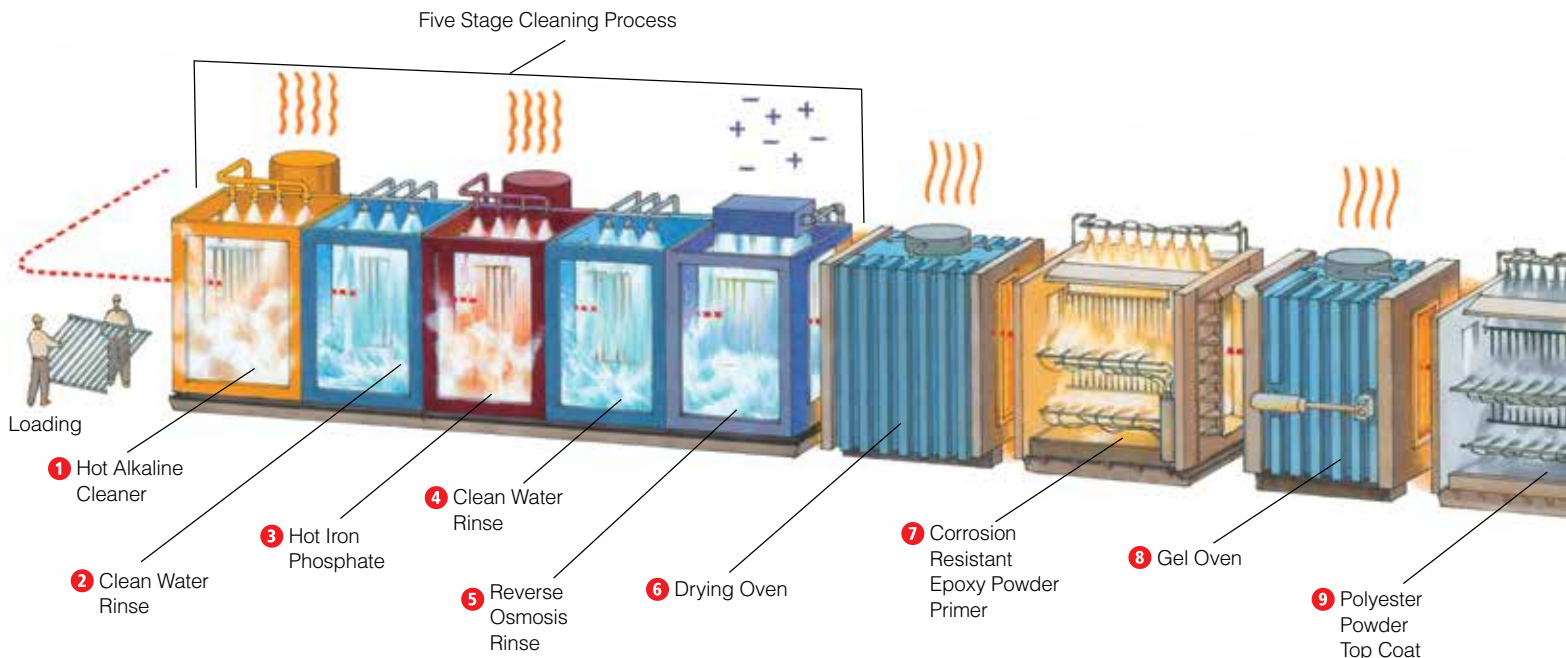

Kent Panels

A traditional design with square top pickets.

Available in 2, 3 or 4 rail styles.

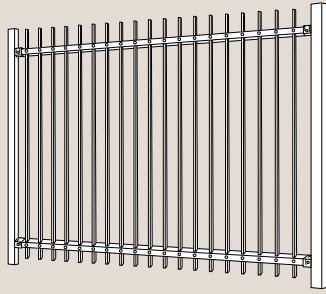

2 Rail

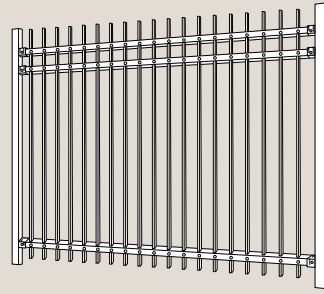

3 Rail

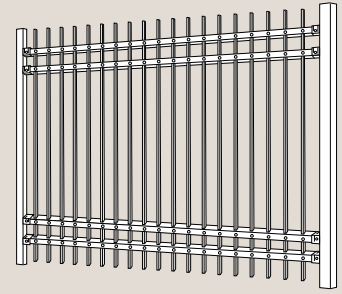

4 Rail

Kent

Monroe Panels

A clean and simple design with no pickets above the top rail.

Available in 2, 3 or 4 rail styles.

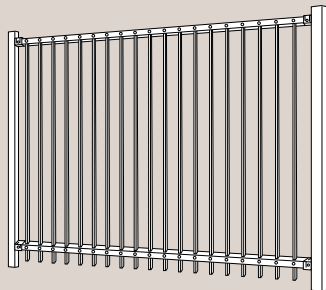

2 Rail

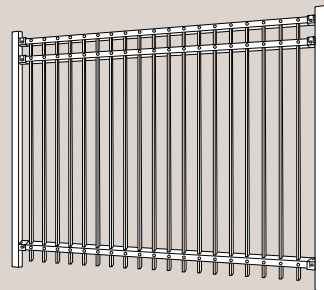

3 Rail

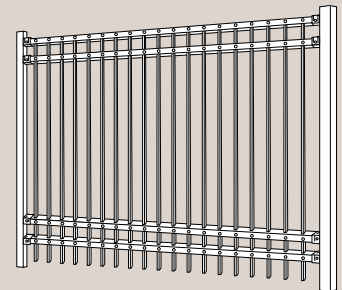

4 Rail

Monroe

Advanced Powder Coating Process

All Guardsman® panels receive Merchants Metals' industry leading 10 stage powder coating process. The first five stages are dedicated to a thorough cleaning, removing any impurities that could potentially mar the finish. After cleaning, the panels are coated with a corrosion resistant zinc rich epoxy primer and a polyester powder top coat, ensuring that each Guardsman® system will be highly resistant to the effects of the elements.

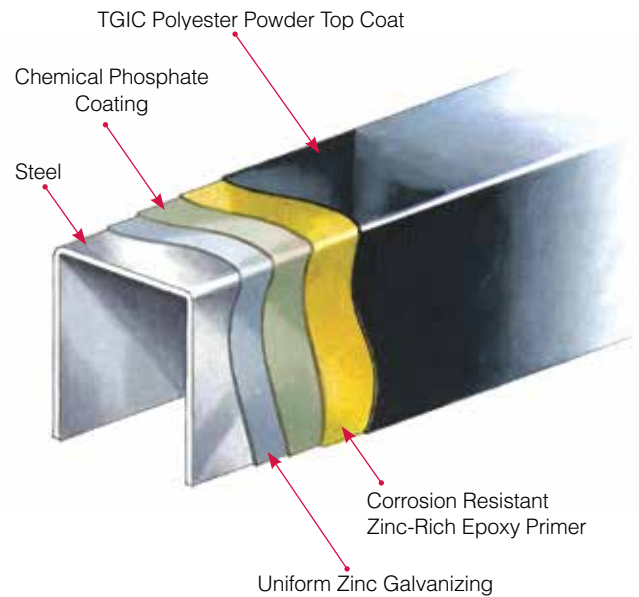

Gates

A large selection of gate sizes and styles are available to coordinate with your Guardsman® fence system.

All are intricately constructed by our skilled craftsmen and receive the Merchants Metals high-quality powder coat finishing.



Lafayette Compound Arch Gate

Single Gates

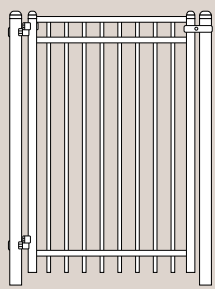

Basic Flat

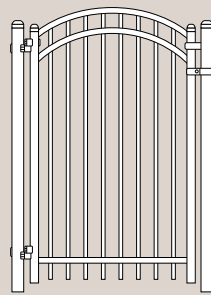

Simple Arch



Monroe 4 Rail Double Gate with Rings

Double Gates

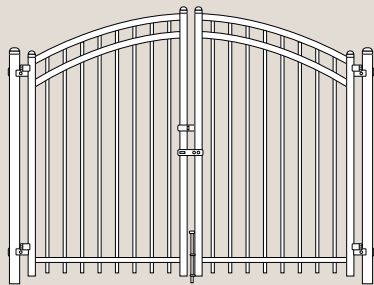

Simple Arch

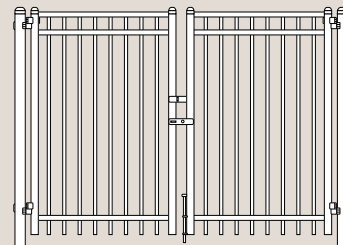

Basic Flat

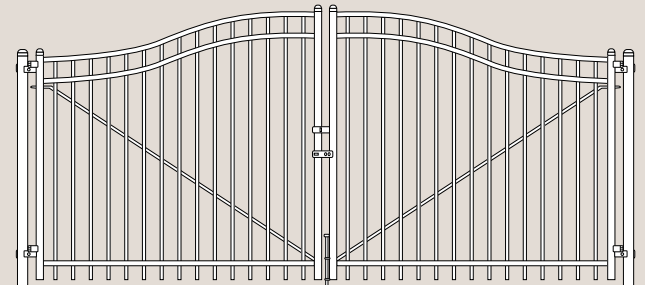

Compound Arch for 10 ft Openings and Larger

Secure-Trac® Cantilever Gate

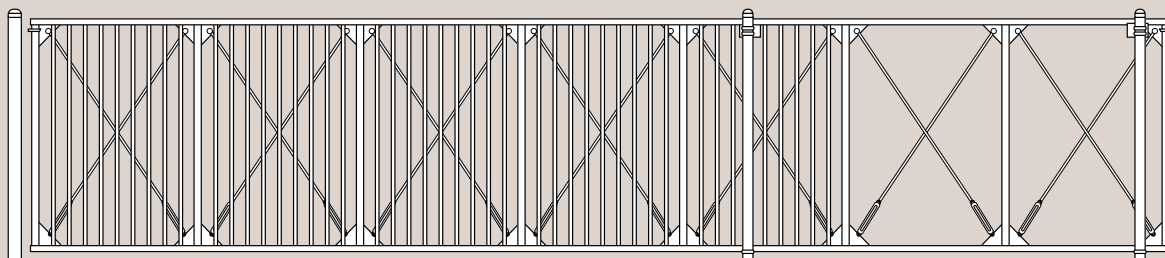

Secure-Trac® internal roller cantilever slide gates are produced using the highest quality materials and workmanship. The fully enclosed rollers eliminate safety issues commonly associated with external rollers and the gates are available to match each style of Guardsman® fence.

Specifications

	Guardsman® Commercial	Guardsman® Industrial
Picket Size	¾ inch square 18 and 16 gauge	1 inch square 18, 16 and 14 gauge
Rail Size	1½ inch X 1½ inch X 11 gauge U-Channel	1½ inch X 1½ inch X 11 gauge U-Channel
Panel Length	90¼ inch	90¼ inch
Number of Pickets	19	18



Mounting Hardware

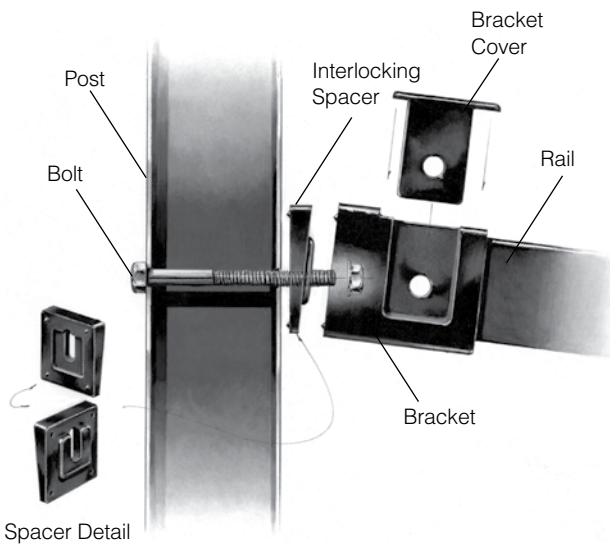

High Security Bracket

The patented High Security Bracket is tamper-resistant and provides an added level of security. The bracket is securely bolted through the post and is fastened to the panel with two rivets which are driven through the bracket cover, bracket and rail.

Spacers can be added between the bracket and post to accommodate grade elevations. Each spacer changes the angle by 7-1/2 degrees and adds 3/8 inch distance between posts. Spacers must be specified when the order is placed.

Additional Bracket Options:



Band Bracket



Universal Bracket



Swivel Bracket

Accessories

Accessories

These beautiful and durable ornamental accessories can be used to add architectural interest to your residential, industrial or commercial property.



Guardsman® fencing and gates are available with optional decorative rings.

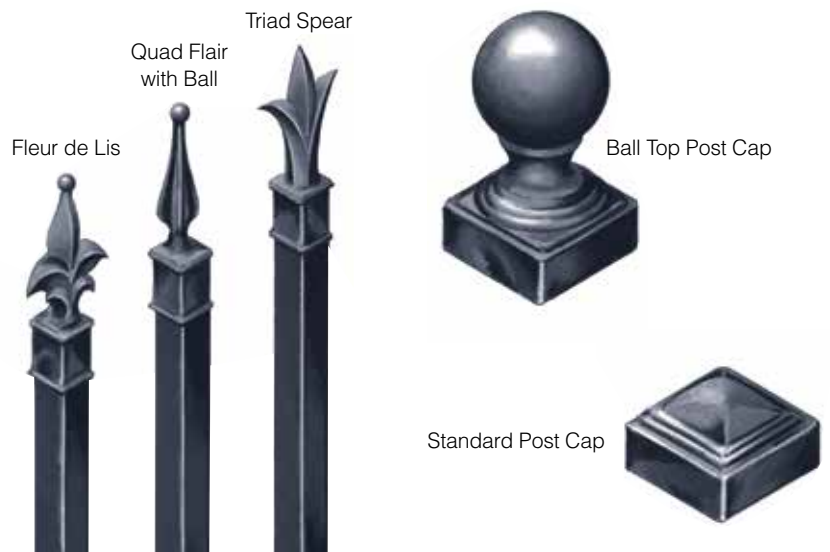

Additional Fence Solutions

Merchants Metals is one of the largest manufacturers and distributors of fence systems in the nation. Our complete line of fencing solutions for residential, commercial and industrial applications includes:

- Hot-Dipped Galvanized Chain Link
- Color Coated Chain Link
- Steel Ornamental in both Component and Fully-Welded Systems
- Aluminum Ornamental Systems
- Wood Fence
- PVC Fence
- Temporary Fence
- Aluminum Track Gates
- Access Control Products
- Guardrail
- Pre-hung Security Gates
- Welded Wire

All Merchants Metals products are available through professional fence contractors nationwide.

To find out more about Merchants Metals and the fencing solutions we offer, please call 866.888.5611 or visit www.merchantsmetals.com.



AIA Continuing Education



ORNAMENTAL



PVC



CHAIN LINK



WOOD



GATES



866.888.5611

www.merchantsmetals.com